

# KOALA





## L I V I N G

### Assembly Instruction

Product Name: Dianne White Grey-Streaked Sintered Stone Coffee Table  
Brushed Gold Stainless Steel Frame

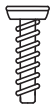

Product Id: 129242

#### Hardware List

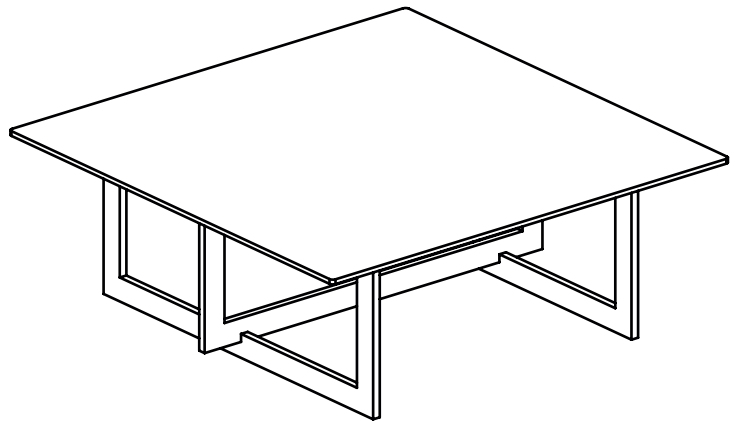
- |   |   |                       |        |
|---|---|-----------------------|--------|
| A |    | Allen Key<br>4mm      | 1 pc   |
| B |   | Allen Bolt<br>M6*70mm | 12 pcs |
| C |  | Allen Bolt<br>M6*10mm | 2 pcs  |
| D |  | Silicon Pad<br>12x2mm | 4 pcs  |

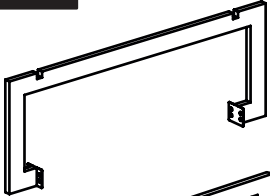

#### Part List

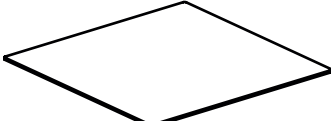
- |            |   |       |
|------------|---|-------|
| Middle Leg |  | 2 pcs |
| Side Leg   |  | 1 pc  |
| Support    |  | 2 pcs |
| Top        |  | 1 pc  |

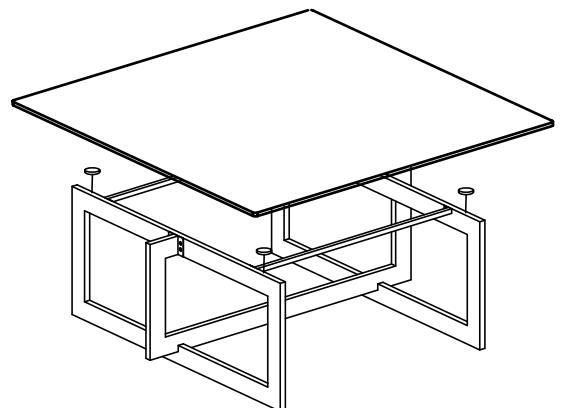

## Note

1. Assemble the item on a soft, well-lit surface like cardboard or carpet.
2. For safety and efficiency, it's best to have two or more people assist with assembly to handle heavy parts safely and collaborate effectively.
3. Keep all packaging materials intact until assembly is complete.
4. Before assembling the item, carefully read all provided instructions.
5. Handle tools with care during assembly to prevent injuries.

1

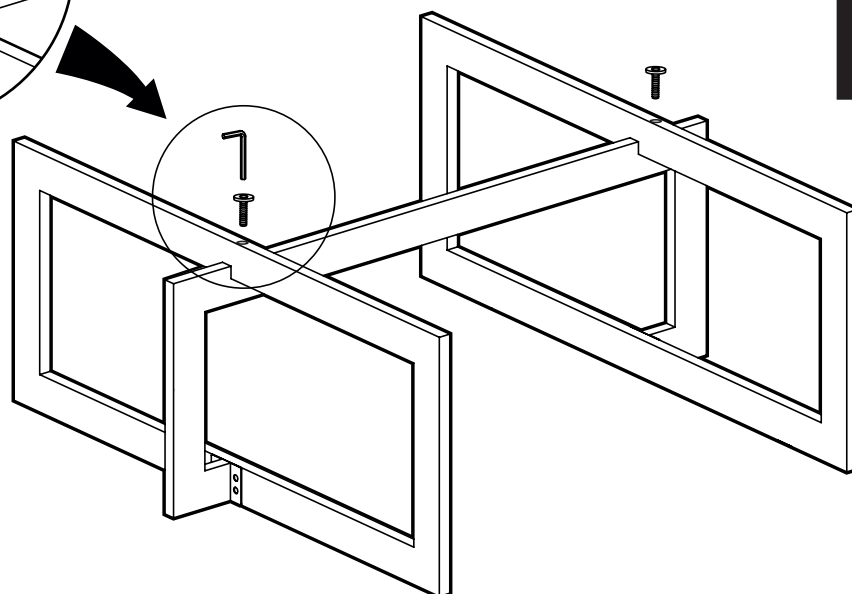
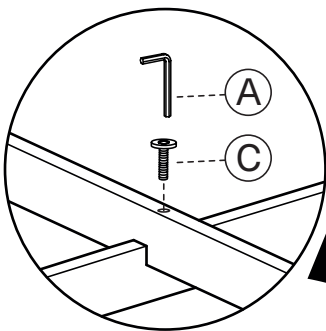
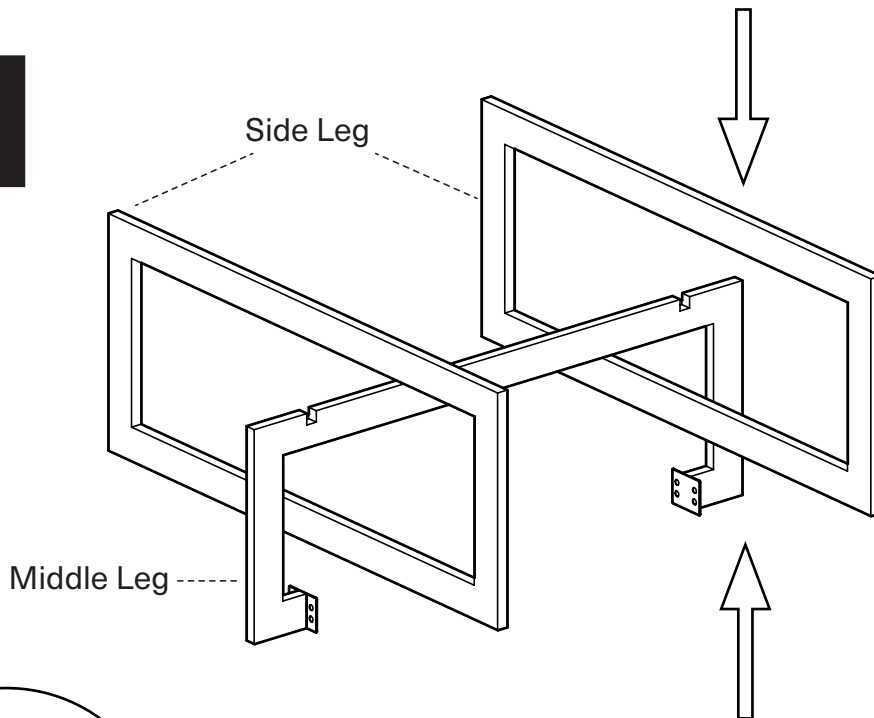

2

3

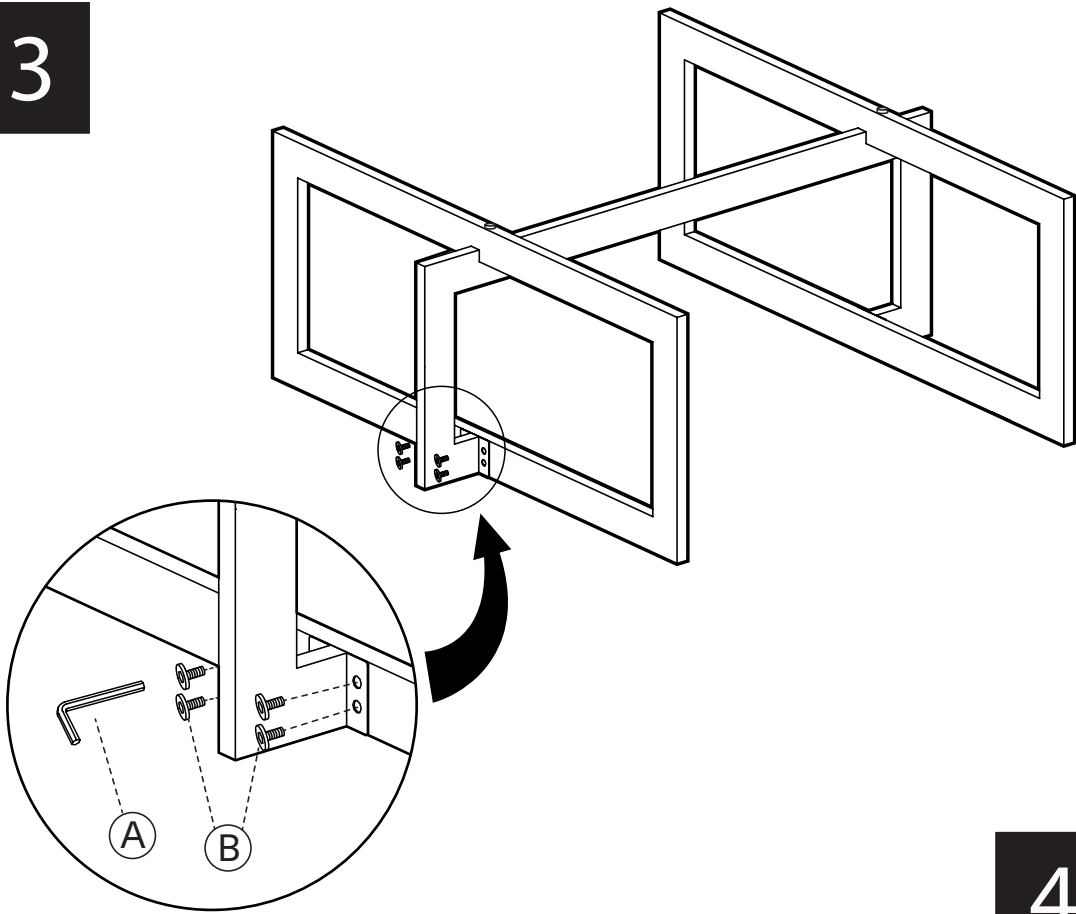

4

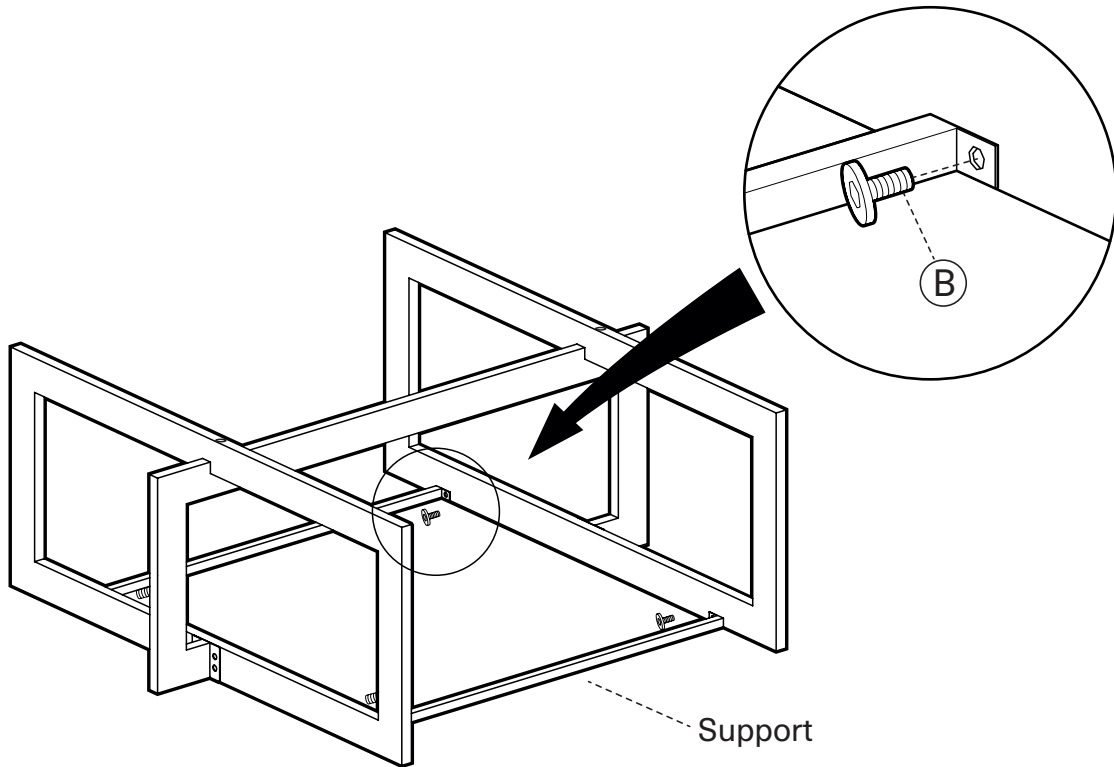

5

Top

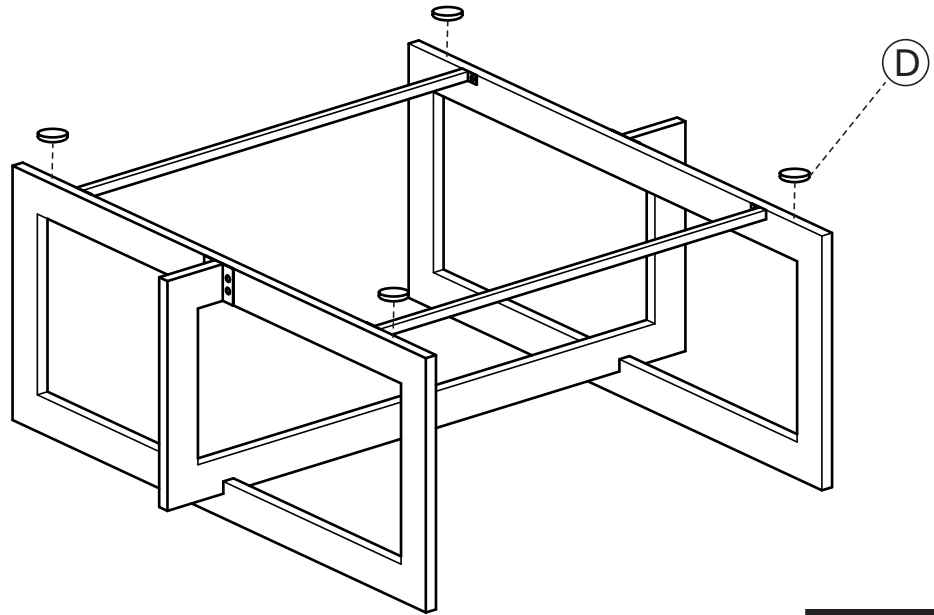
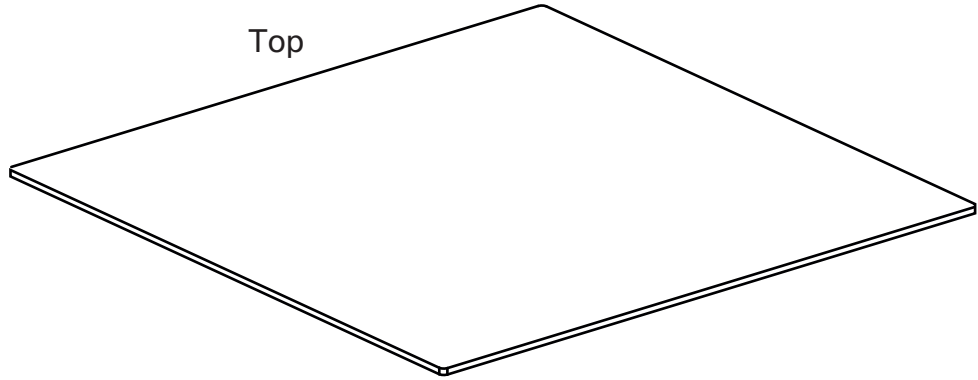
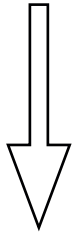

6

