

KOALA



L I V I N G

Assembly Instruction

Product Name: Kelly Charcoal Velvet 2-Seater Sofa - Black Nickel Legs

Product Id: 128507

Hardware List

- A  Allen Key 5x66X23mm 1 pc
- B  Allen Bolt M8x90mm 8 pcs
- C  Gasket 1 pc

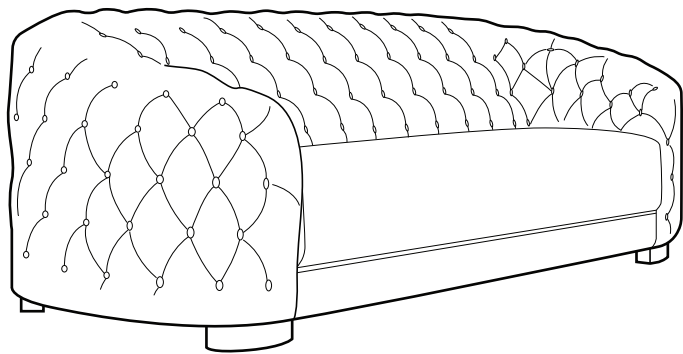

Part List

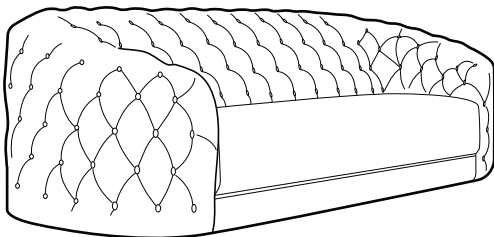

2 Seater Sofa
1 pc

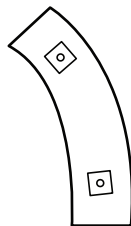

Leg A
2 pcs

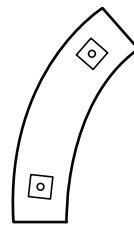

Leg B
2 pcs

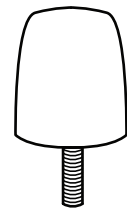

Support Leg
1 pc

Note

1. Assemble the item on a soft, well-lit surface like cardboard or carpet.
2. For safety and efficiency, it's best to have two or more people assist with assembly to handle heavy parts safely and collaborate effectively.
3. Keep all packaging materials intact until assembly is complete.
4. Before assembling the item, carefully read all provided instructions.
5. Handle tools with care during assembly to prevent injuries.

1

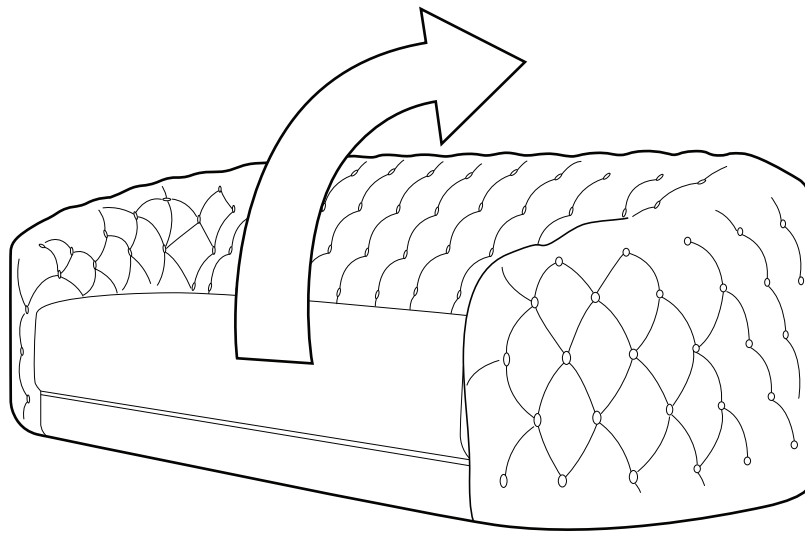

Position the product on its bottom as shown

2

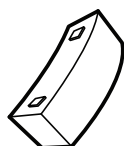
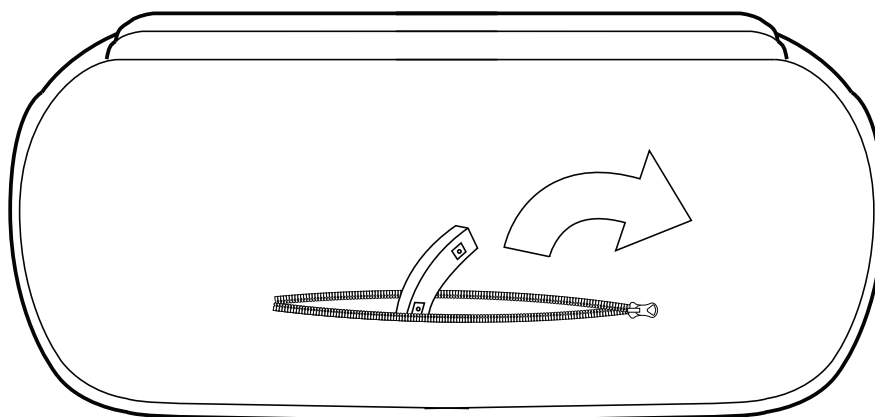

Leg A
2 pcs

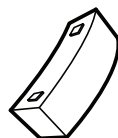

Leg B
2 pcs

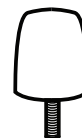

Support Leg
1 pc

3

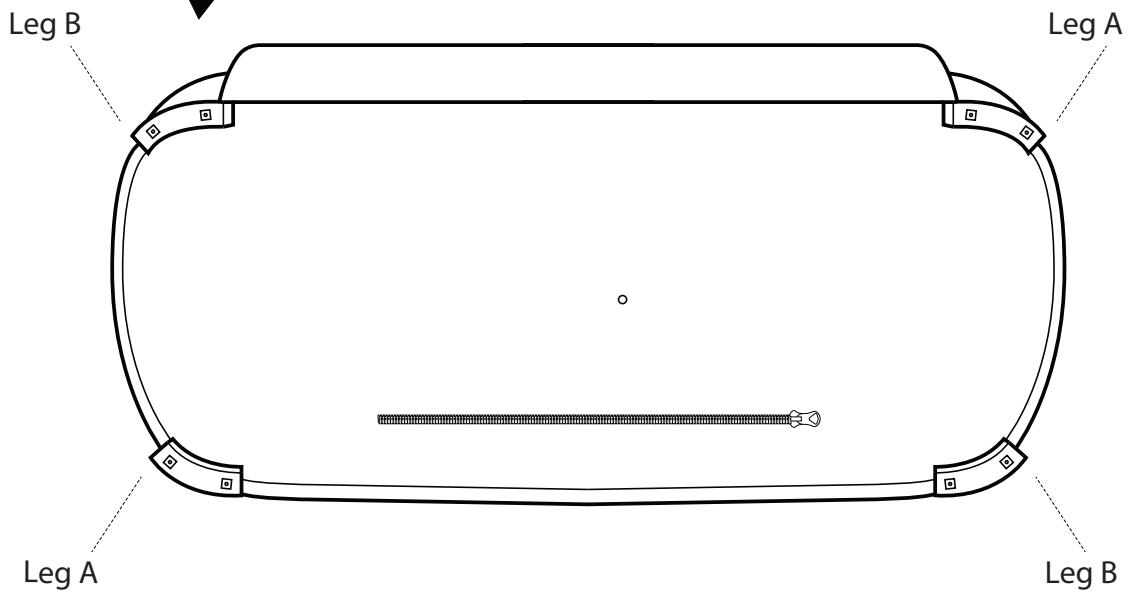
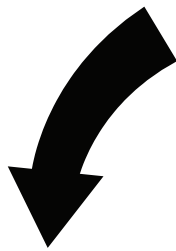
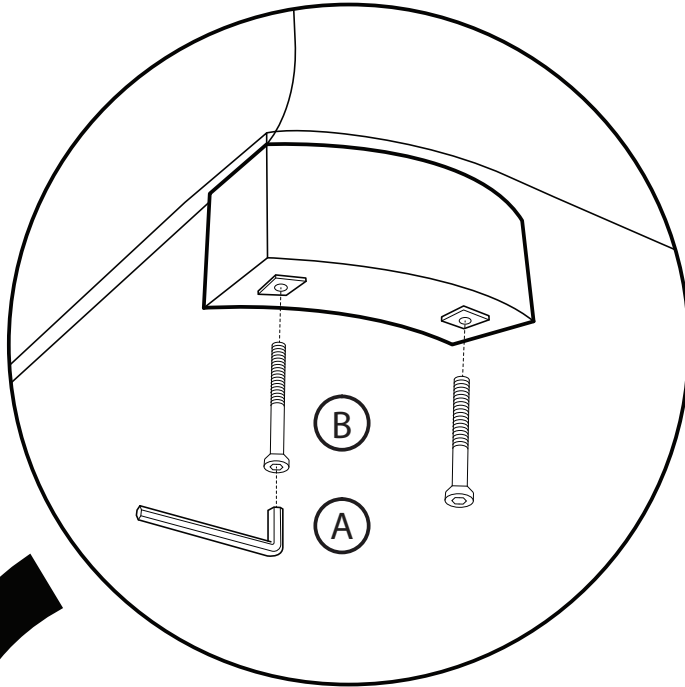

4

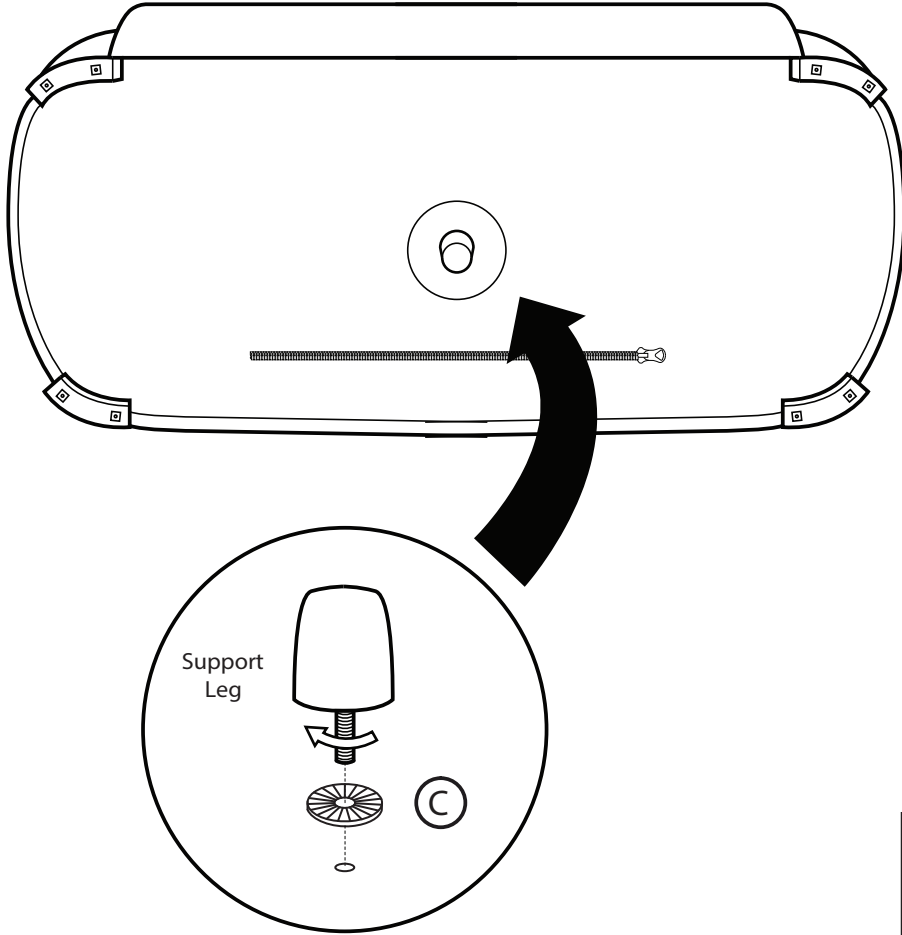

5

