

# KOALA







## L I V I N G

### Assembly Instruction

Product Name: Diana Brushed Gold Metal Floor Lamp White Metal Shade

Product Id: 128339

#### Hardware List

A		Finial	1 pc
B		Saddle	1 pc
C		Rubber Gasket	1 pc
D		Metal Pads	1 pc
E		Stents	1 pc
F		E27 Bulb (not included)	3 pcs
G		Socket	3 pcs

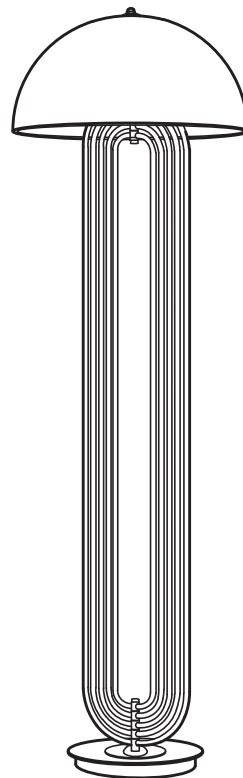

#### Part List

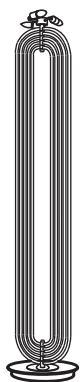

1pc

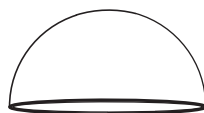

1pc

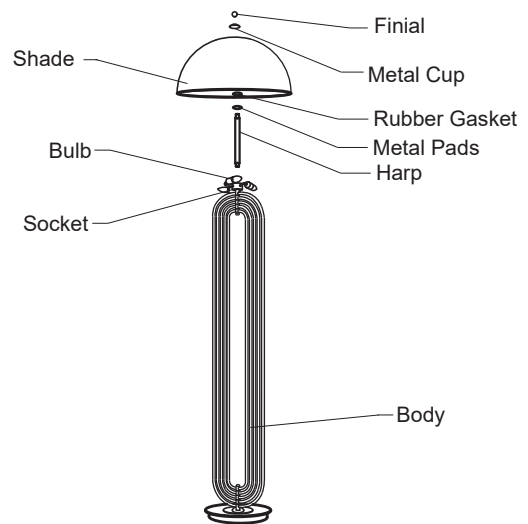

## Note

1. Assemble the item on a soft, well-lit surface like cardboard or carpet.
2. Keep all packaging materials intact until assembly is complete.
3. Before assembling the item, carefully read all provided instructions and check all parts and components.
4. Handle tools with care during assembly to prevent injuries.
5. Assemble procedure with pictorial (illustration) presentation.

1

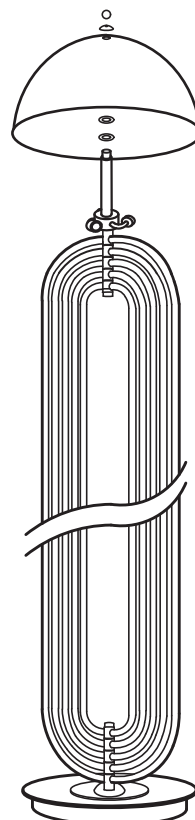
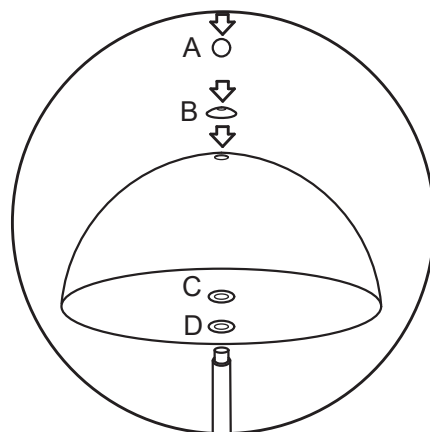
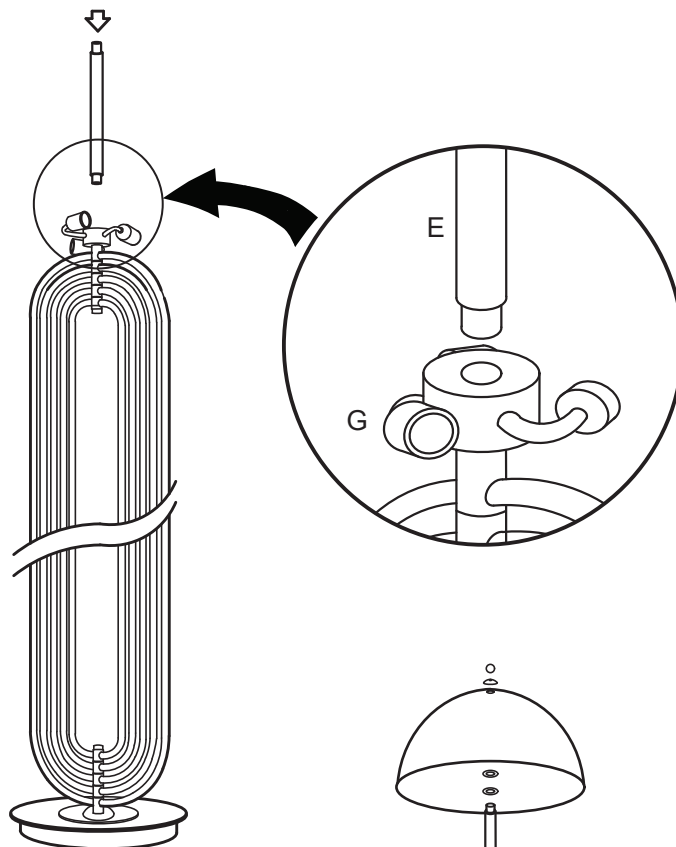

2

3

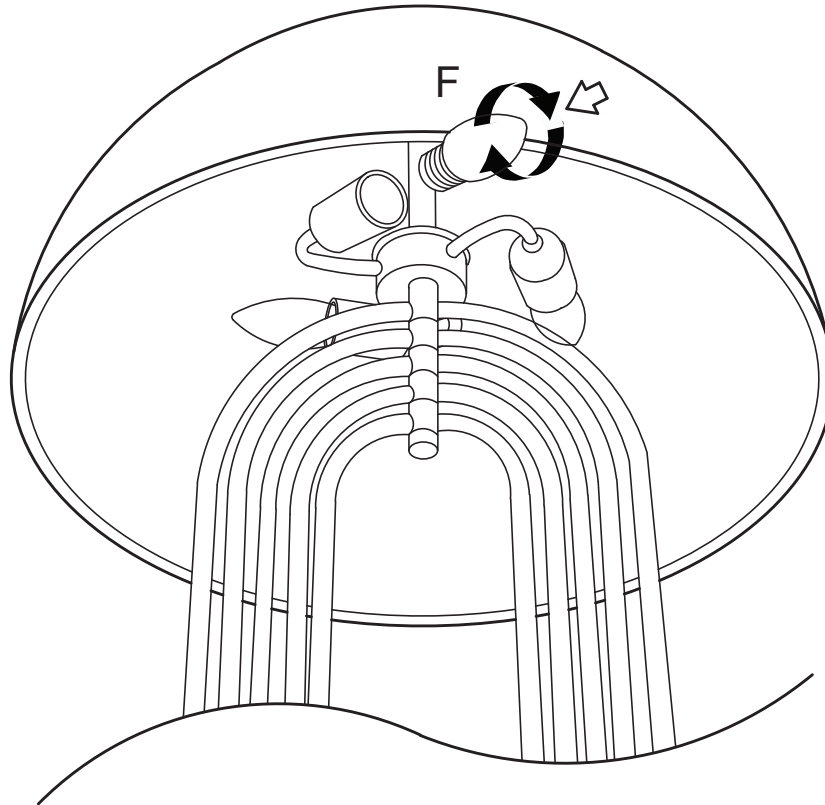

### Important Safety Instruction

This portable luminaire has a polarized plug (one blade is wider than the other) as a safety feature to reduce the risk of electric shock. This plug will fit in a polarized outlet only one way. If it does not fit fully in the outlet, reverse the plug. If it still does not fit, contact qualified electrician. Never use with an extension cord unless the plug can be fully inserted. Do not alter the plug.

220-240V a.c, 50Hz E27; Max.25W ta:25°C

If the external flexible cable or cord this luminaire is damaged, it shall be exclusively replaced by the manufacturer or his service agent or a similar qualified person in order to avoid a hazard.

