

KOALA







L I V I N G

Assembly Instruction

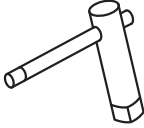
Product Name: Jutta Glass 120cm Dining Table - Antique Brass Colour Legs

Product Id: 127667

Hardware List

- | | | |
|---|---|------------------|
| A |  | 3pcs |
| B |  | 3pcs |
| C |  | 3pcs |
| D |  | 3pcs |
| E |  | 1pc |
| F |  | M6*15mm
6pcs |
| G |  | M6*12mm
12pcs |

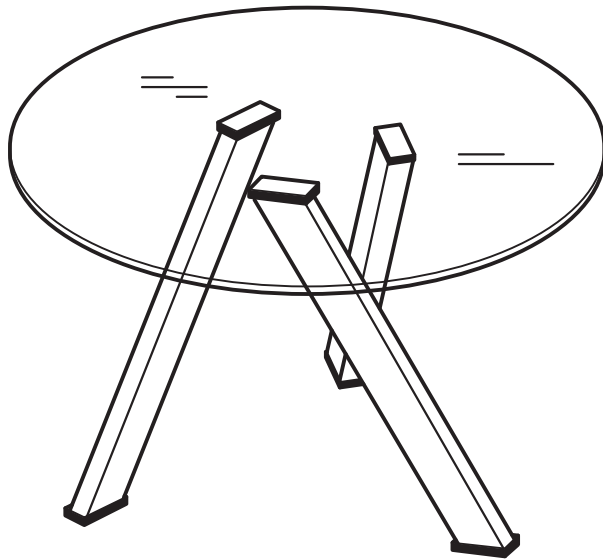

Part List

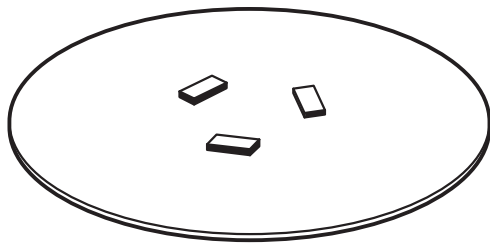

1pc

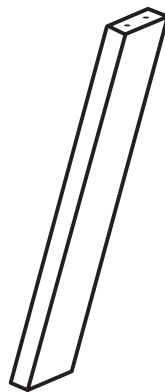

3pcs



3pcs

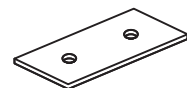

3pcs

Note

1. Assemble the item on a soft, well-lit surface like cardboard or carpet.
2. For safety and efficiency, it's best to have two or more people assist with assembly to handle heavy parts safely and collaborate effectively.
3. Keep all packaging materials intact until assembly is complete.
4. Before assembling the item, carefully read all provided instructions.
5. Handle tools with care during assembly to prevent injuries.

1

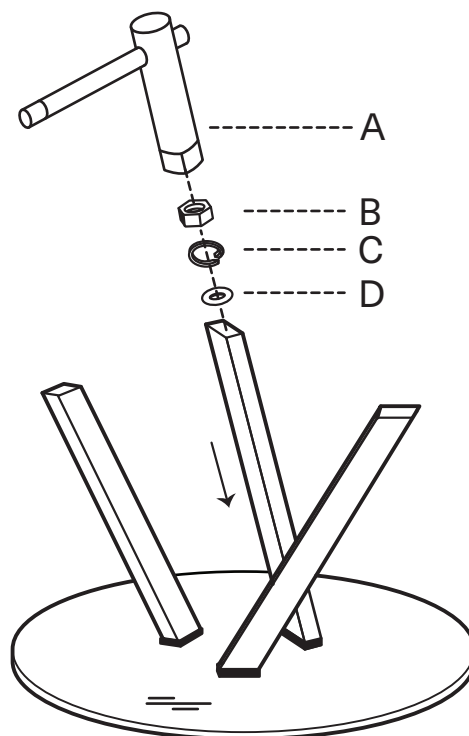
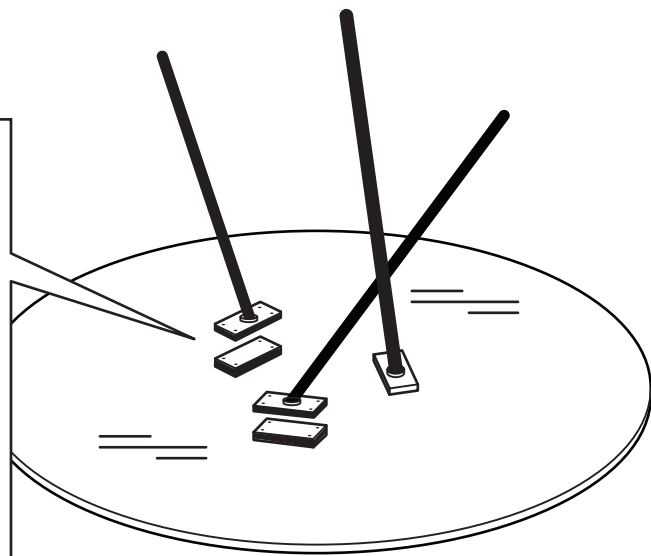
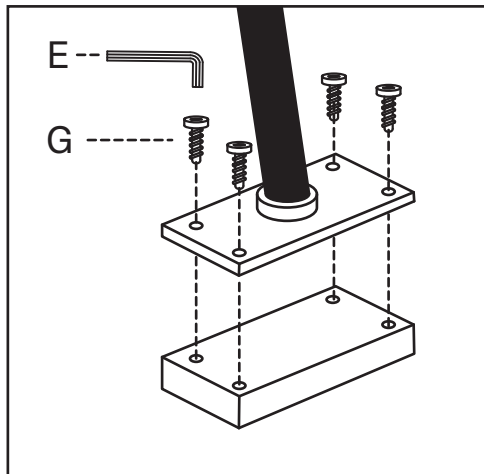

2

3

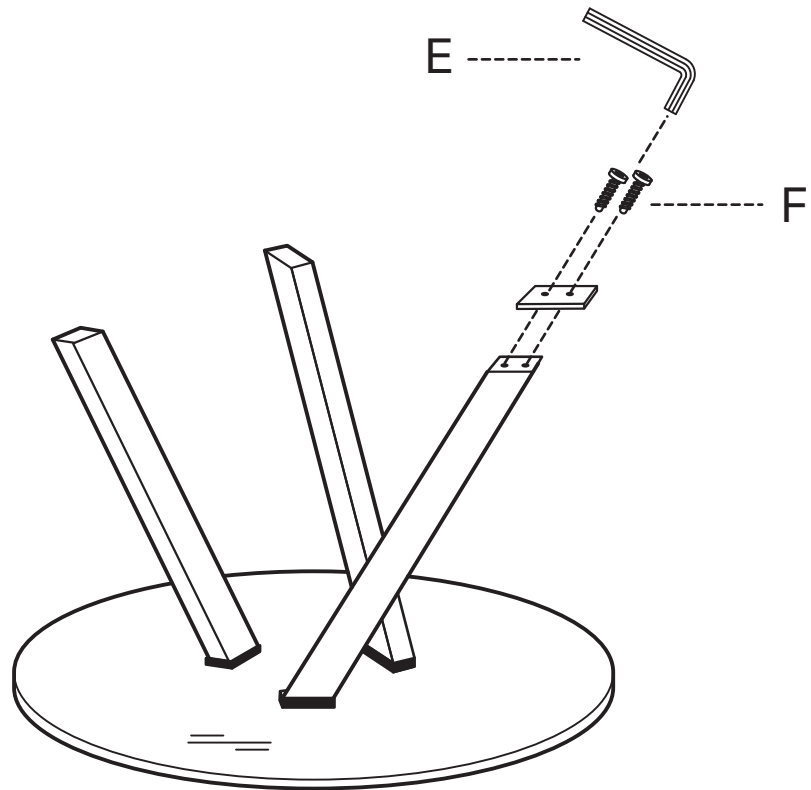

4

