





KOALA

L I V I N G

Assembly Instruction

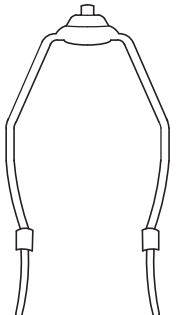
Product Name: Nela Crystal and Brushed Bronze Metal Floor Lamp - White Linen Lamp Shade
 Product Id: 126532

Hardware List

A		Finial	1 pc
B		Harp	1 pc
C		E27 Bulb (not included)	1 pc
D		Socket /holder	1 pc
E		Saddle	1 pc



A full assembly diagram of the floor lamp, showing the lampshade, harp, socket, saddle, post, and base. A QR code is located in the top right corner of this section.

Part List

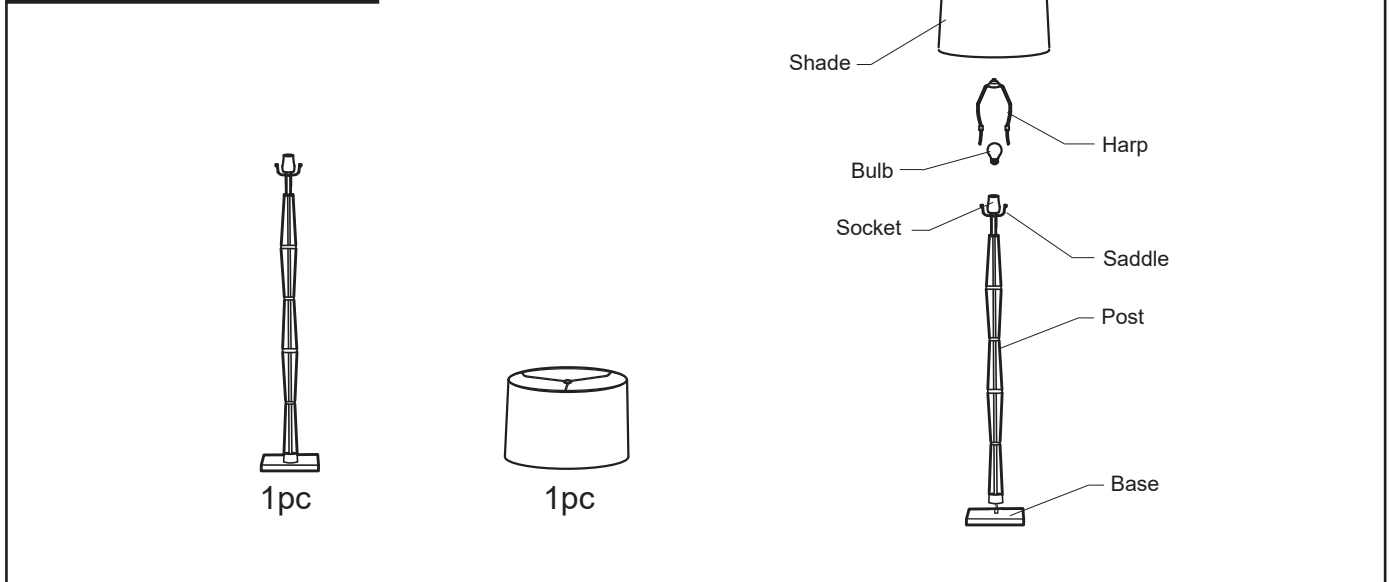

Part list diagram showing individual components and their quantities:

- 1pc: Lamp post (without shade)
- 1pc: Lamp shade

Labels for the lamp assembly diagram:

- Shade
- Finial
- Bulb
- Harp
- Socket
- Saddle
- Post
- Base

Note

1. Assemble the item on a soft, well-lit surface like cardboard or carpet.
2. Keep all packaging materials intact until assembly is complete.
3. Before assembling the item, carefully read all provided instructions and check all parts and components.
4. Handle tools with care during assembly to prevent injuries.
5. Assemble procedure with pictorial (illustration) presentation.

1

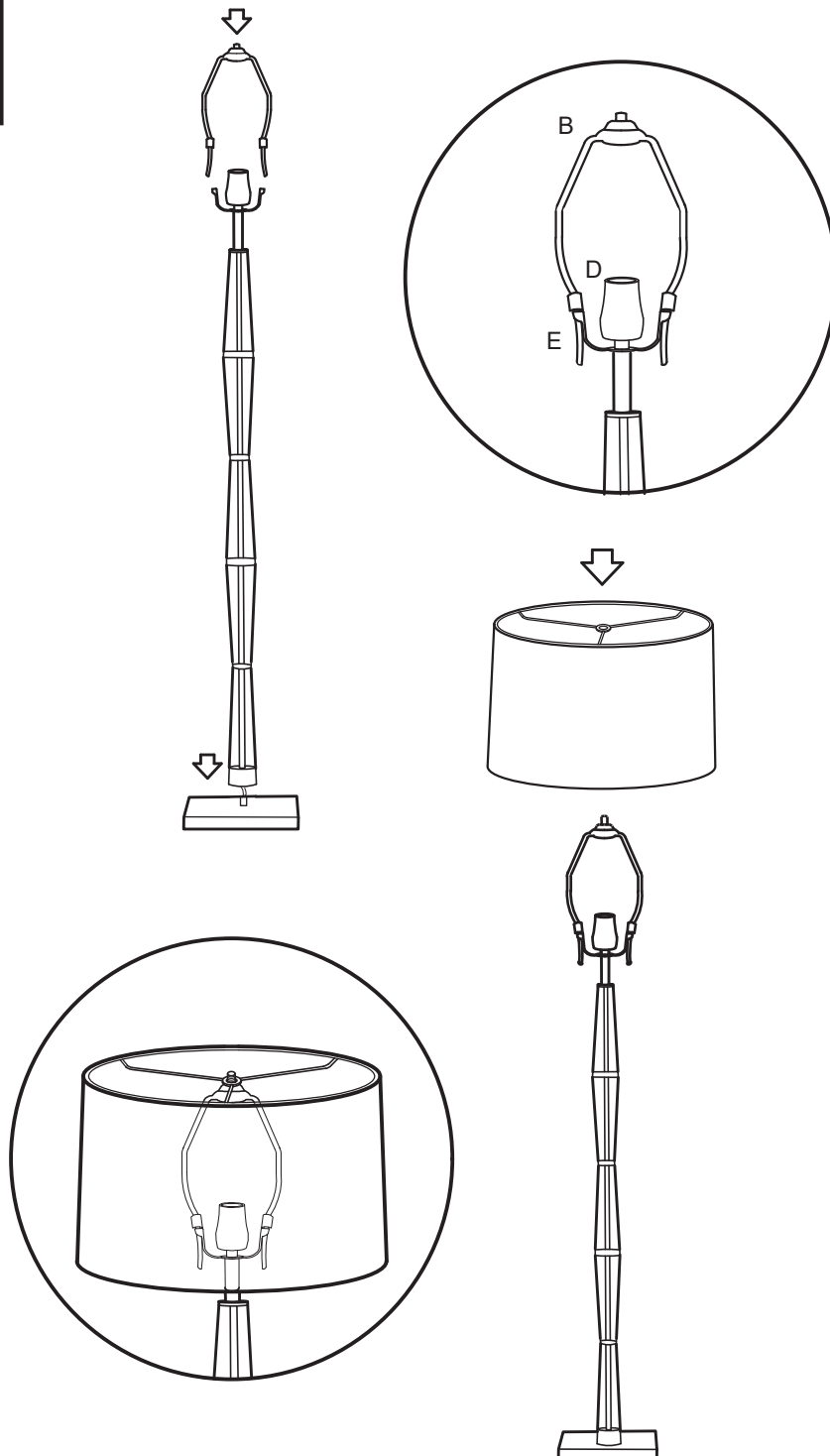

2

3

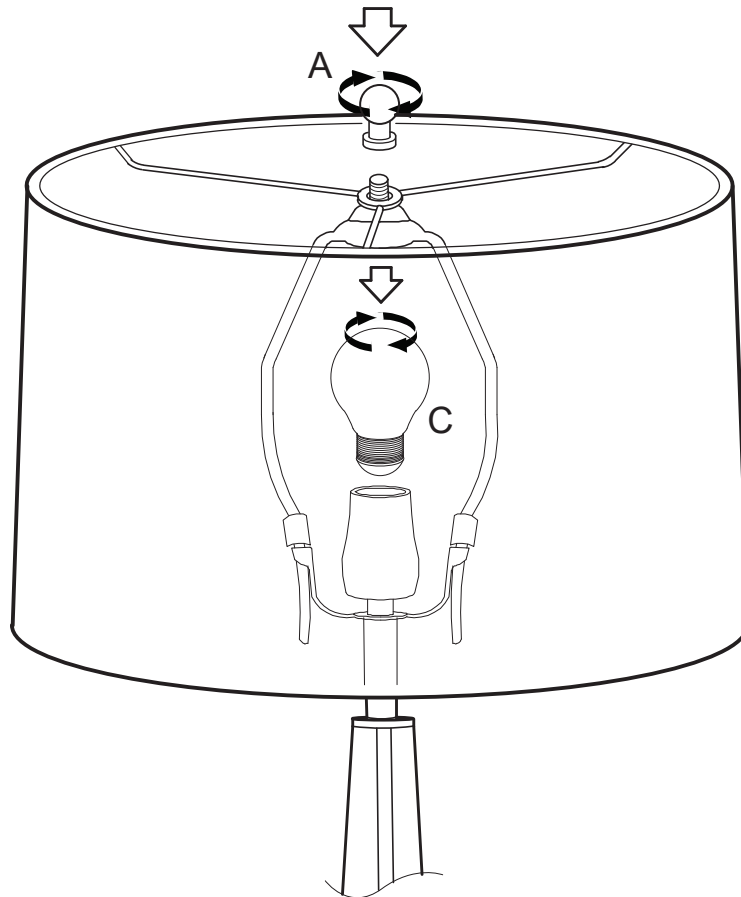

Important Safety Instruction

This portable luminaire has a polarized plug (one blade is wider than the other) as a safety feature to reduce the risk of electric shock. This plug will fit in a polarized outlet only one way. If it does not fit fully in the outlet, reverse the plug. If it still does not fit, contact qualified electrician. Never use with an extension cord unless the plug can be fully inserted. Do not alter the plug.

220-240V a.c, 50Hz E27; Max.25W ta:25°C

If the external flexible cable or cord this luminaire is damaged, it shall be exclusively replaced by the manufacturer or his service agent or a similar qualified person in order to avoid a hazard.

