

KOALA







L I V I N G

Assembly Instruction

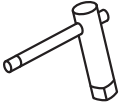
Product Name: Jutta Glass 120cm Dining Table - Stainless Steel Legs

Product Id: 125778

Hardware List

A		Spanner	1 pc
B		Nut	3 pcs
C		Spring Washer	3 pcs
D		Washer	3 pcs
E		Allen Key	1 pc
F		Allen Bolt M6*15mm	6 pcs
G		Allen Bolt M6*12mm	12 pcs

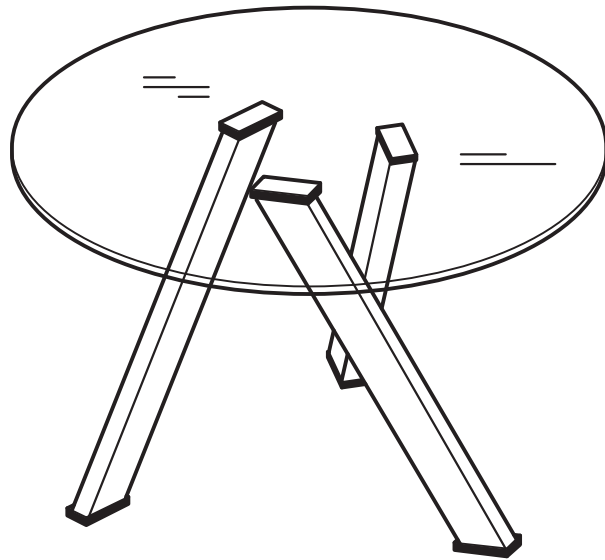

Part List

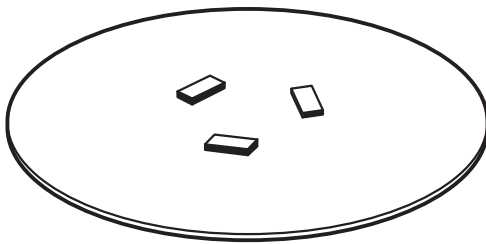

1pc

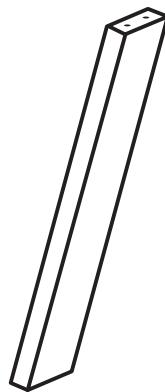

3pcs



3pcs

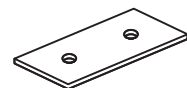

3pcs

Note

1. Assemble the item on a soft, well-lit surface like cardboard or carpet.
2. For safety and efficiency, it's best to have two or more people assist with assembly to handle heavy parts safely and collaborate effectively.
3. Keep all packaging materials intact until assembly is complete.
4. Before assembling the item, carefully read all provided instructions.
5. Handle tools with care during assembly to prevent injuries.

1

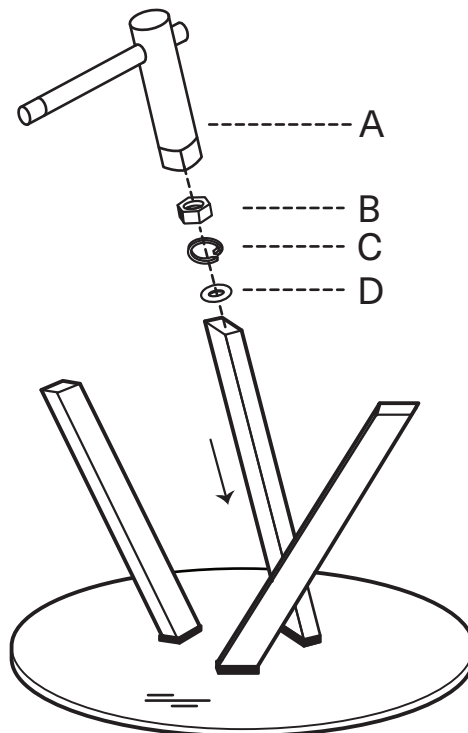
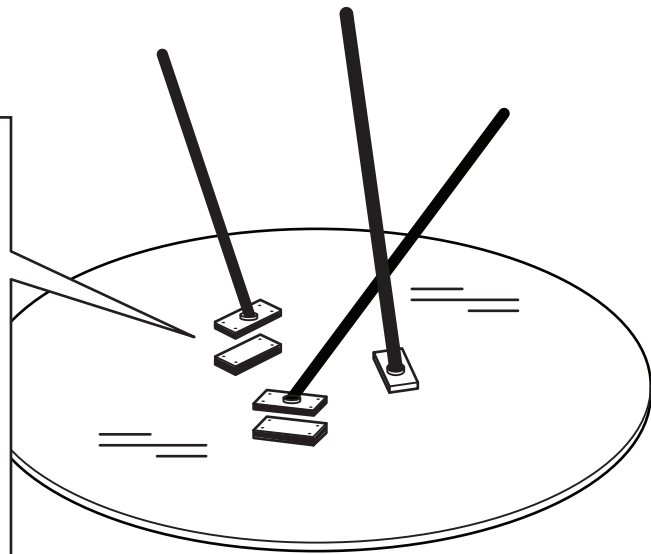
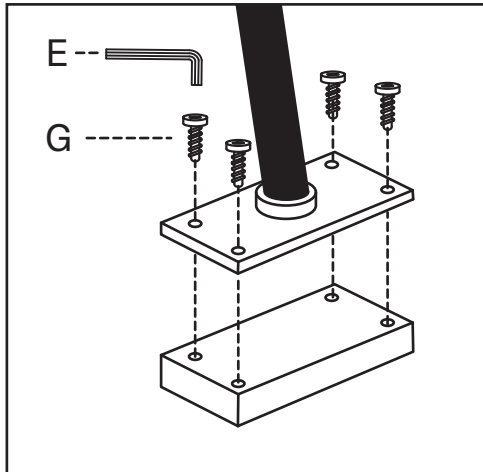

2

3

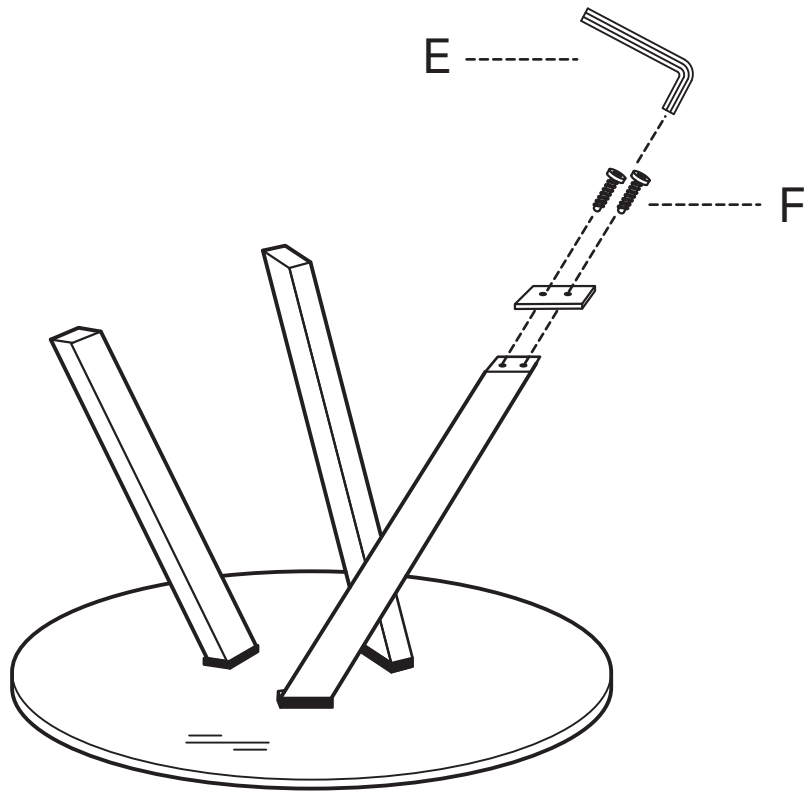

4

